

# Product datasheet

Specifications



single phase power supply,  
100...240V input, 24V DC output,  
156W, 6,5A

ABL2REM24065K

## Main

Range of product	Easy Modicon ABL2
product or component type	Power supply
Power supply type	Regulated switch mode
Rated power in W	156 W
Main Input Voltage	100...120 V AC single phase 200...240 V
Output voltage	24 V DC
Power supply output current	6.5 A
Operating position	Any position
Vibration resistance	4 gn (f= 10...500 Hz) conforming to IEC 61131-2
Name of test	Electromagnetic hypersensitivity (EHS) conforming to IEC 61000-6-2 level A

## Complementary

Input voltage limits	176...264 V 88...132 V
Network frequency	47...63 Hz
Inrush current	60 A at 100...120 V AC 60 A at 200...240 V AC
Cos phi	0.45
Efficiency	89 %
Power dissipation in W	19.3 W
Current consumption	1.5 A at 240 V
Input protection type	Integrated fuse (not interchangeable)
Output voltage limits	20.4...27.6 V
Line and load regulation	+/- 1 %
Holding time	>= 35 ms at 115 V
Output protection type	Against overload, protection technology: 1.1...1.5 x In Against short-circuits, protection technology: 1.1...1.5 x In Against overvoltage, protection technology: 28.8...33.6 V Thermal
Connections - terminals	For ground connection: screw type terminals, connection capacity: 1 x 4 mm <sup>2</sup> AWG 12
marking	CE
Electromagnetic compatibility	Immunity to electromagnetic interference conforming to EN 55022 class B

<b>mounting support</b>	DIN rail with accessory Panel mounting with accessory
<b>Operating altitude</b>	5000 m
<b>Output coupling</b>	Series
<b>Overvoltage category</b>	II
<b>Meantime between failure [MTBF]</b>	600000 h at 25 °C
<b>Status LED</b>	1 LED (green) output voltage
<b>Width</b>	159 mm
<b>Height</b>	97 mm
<b>Depth</b>	30 mm
<b>net weight</b>	0.44 kg

## Environment

<b>Product certifications</b>	EAC IC RoHS KC RCM
<b>IP degree of protection</b>	IP20 conforming to IEC 62368-1
<b>Ambient air temperature for operation</b>	-30...70 °C (with power derating of 2 % per °C)
<b>Ambient air temperature for storage</b>	-40...85 °C
<b>Relative humidity</b>	10...95 %
<b>Overvoltage category</b>	Class I conforming to IEC 62368-1
<b>Pollution degree</b>	2
<b>Dielectric strength</b>	2000 V between input and ground

## Packing Units

<b>Unit Type of Package 1</b>	PCE
<b>Number of Units in Package 1</b>	1
<b>Package 1 Height</b>	3.589 cm
<b>Package 1 Width</b>	10.33 cm
<b>Package 1 Length</b>	16.664 cm
<b>Package 1 Weight</b>	440.0 g
<b>Unit Type of Package 2</b>	S03
<b>Number of Units in Package 2</b>	35
<b>Package 2 Height</b>	30.0 cm
<b>Package 2 Width</b>	30.0 cm
<b>Package 2 Length</b>	40.0 cm
<b>Package 2 Weight</b>	16.47 kg

## Sustainability

**Green Premium™ label** is Schneider Electric's commitment to delivering products with best-in-class environmental performance. Green Premium promises compliance with the latest regulations, transparency on environmental impacts, as well as circular and low-CO<sub>2</sub> products.

**Guide to assessing product sustainability** is a white paper that clarifies global eco-label standards and how to interpret environmental declarations.

[Learn more about Green Premium >](#)

[Guide to assess a product's sustainability >](#)

## Well-being performance

 Reach Free Of Svhc

---

 Rohs Exemption Information [Yes](#)

---

**Reach Regulation** [REACH Declaration](#)

---

**Eu Rohs Directive** Pro-active compliance (Product out of EU RoHS legal scope)

---

**China Rohs Regulation** [China RoHS declaration](#)

---

Dimensions Drawings

Dimensions Drawings

Mechanical Dimensions

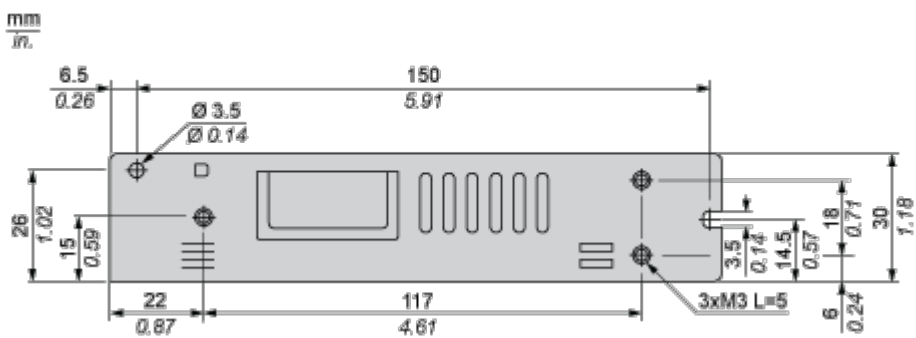
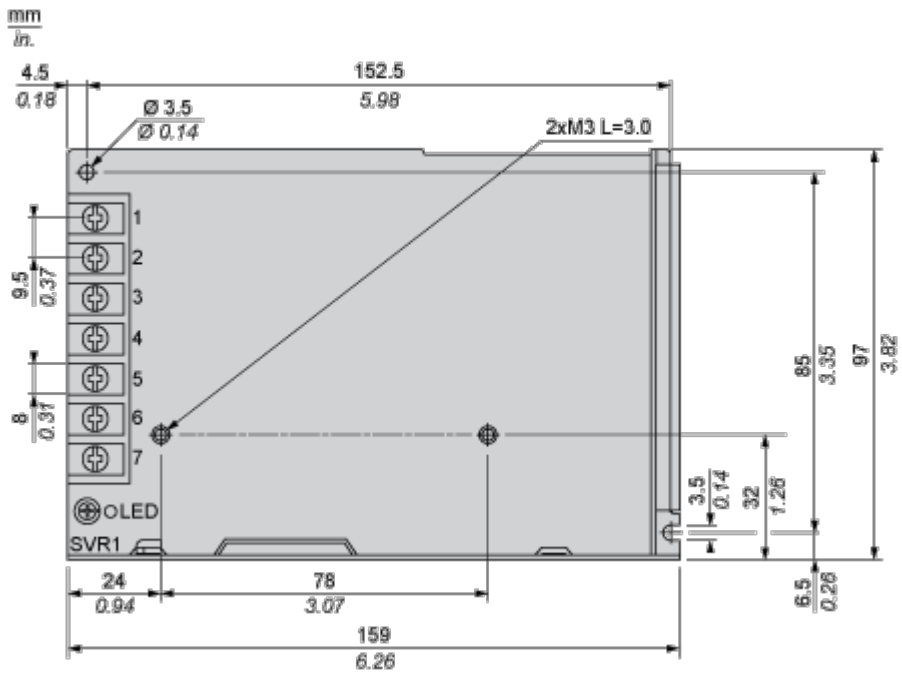

Mounting and Clearance

Mounting and Clearance

---

Vertical Mounting

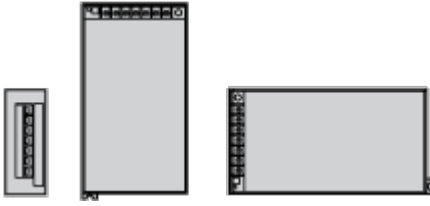

Horizontal Mounting



Clearance

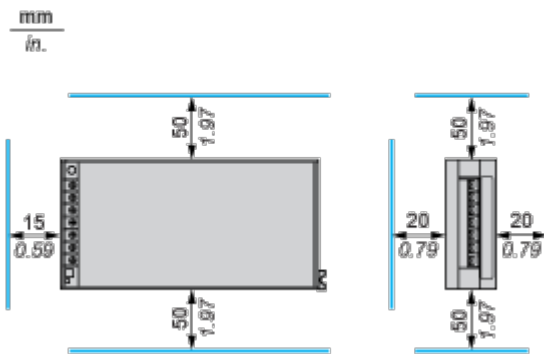

Performance Curves

Performance Curves

---

Static Characteristics

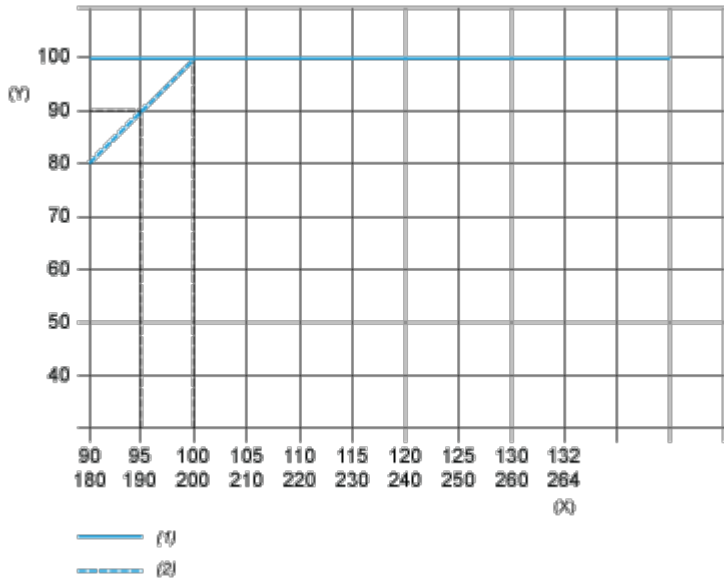

- (1) 180 - 264 VAC
- (2) 90 - 132 VAC
- (y) Load %
- (x) Input voltage (VAC) 50/60 Hz

Derating Curve

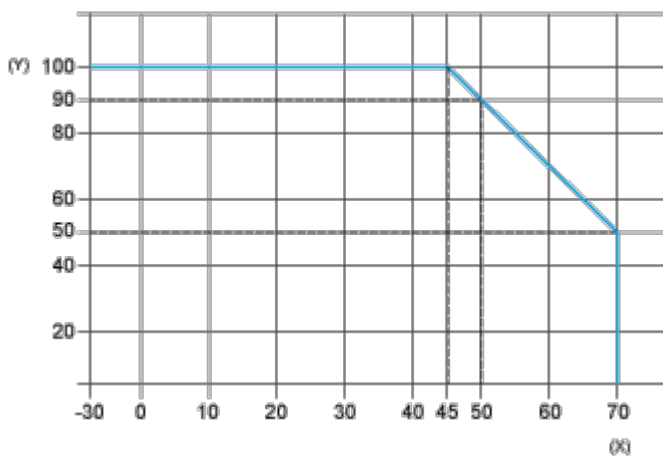

- (y) Load %
- (x) Ambient temperature (°C)